

ALDRIDGE

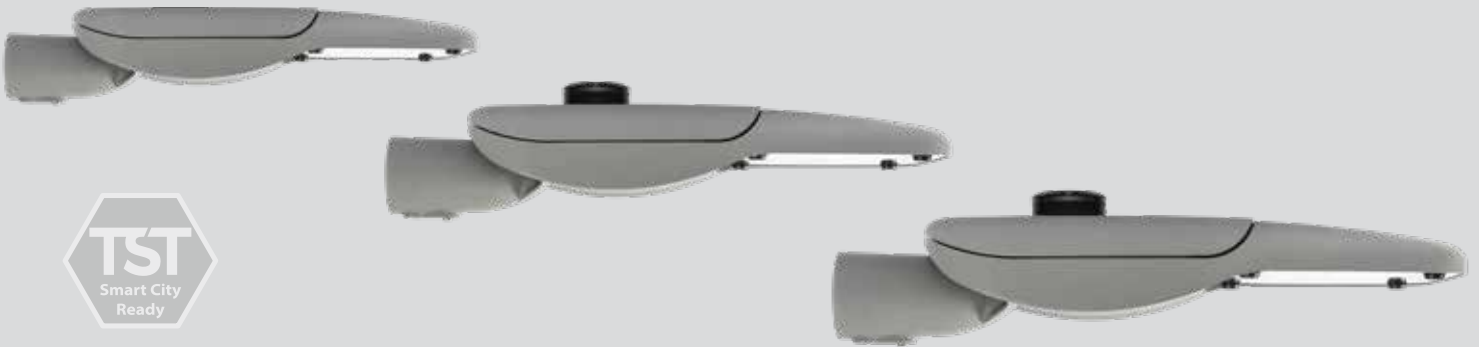

FLAT SERIES



P-Cat. Roads, Walkways, Car Parks



APPLICATIONS

- 'P' Category Roadways
- Suburban Roads
- Walkways
- Parks
- Including 'P4' & 'P5'
- Driveways
- Car Parks
- Security Lighting



FLAT Series

Aesthetically low profile street and area lighting system.

A versatile range, available in three sizes, small, medium and large to suit today's ever changing landscape and withstand the test of time in hardware, optics, environment and performance.

Dimensions

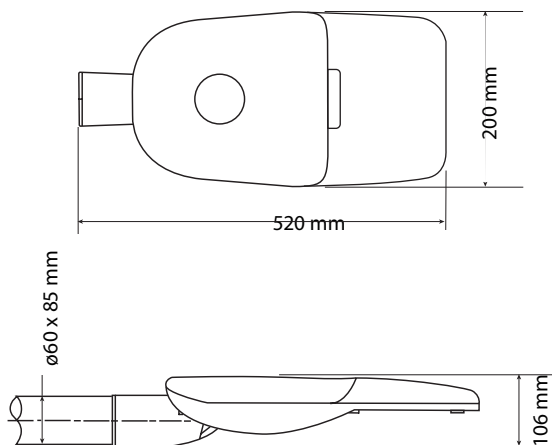
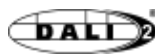

Features

- Smart City Ready - TST compatibility Zigbee, LoRa, NBloT
- High Performance luminaire designed to meet stringent Australian Standards AS/NZS 1158.6
- High Performance Optics designed to meet and comply Australian standards AS1158.3.1
- Integrated thermal management
- Segregated termination point
- Hinged 'quick access latch'
- Self-cleaning housing and optical diffuser
- 7-pin Nema Receptacle (7PN)
- Supports DALI-2 connection and complies with D4i
- 10 year warranty

Technical Data

- Body:** High Pressure Marine Grade Die Cast Aluminum
- Optics:** Type T2, T3, T3M, T3N, T4, T4D Distribution
- LED #:** 8 - 16 - 24
- Wattage:** 20 - 25 - 30 - 40 - 60 Watts
- Finishing:** Powder Coat (Grey Standard)
- Mounting:** 4 - 6 Metres
- Fixing:** Top or Side Mount (60mm OD)
- IP rating:** IP66
- IK rating:** IK08
- Voltage:** 240V 50/60Hz
- Power Factor:** >0.9

Options

- Fuse Terminal Block:** (FTB)
- Surge Protection Device:** SPD - 10KVA, 20KVA
- DALI-2, D4i**
- Street Light Controller:** Zhaga
- Class II:** (DB - Double Insulated)
- Colour:** Black (BL), Grey (GR-Standard)
- CCT:** 3000K, **4000K (Standard)**, 5000K
- Visor:** Glaeshield/spill light kit (GV)
- Spigot Adapters Available:** 60mm to 34mm, 60mm to 42mm (OD), 60mm to 48mm (OD)

Specification FLAT-S

PRODUCT CODE	FL.S.20W	FL.S.25W	FL.S.30W	FL.S.40W	FL.S.60W
Photometric Distribution	T2, T3, T3M, T3N, T4, T4D	T2, T3, T3M, T3N, T4, T4D	T2, T3, T3M, T3N, T4, T4D	T2, T3, T3M, T3N, T4, T4D	T2, T3, T3M, T3N, T4, T4D
System Watts	20	25	30	40	60
Input Voltage (V)	240	240	240	240	240
CCT (K)	4000	4000	4000	4000	4000
CRI	Ra>70	Ra>70	Ra>70	Ra>70	Ra>70
IP Protection	IP66	IP66	IP66	IP66	IP66
IK Protection	IK08	IK08	IK08	IK08	IK08
Weight (Kg) - max.	6.1	6.1	6.1	6.2	6.2

Photometrics

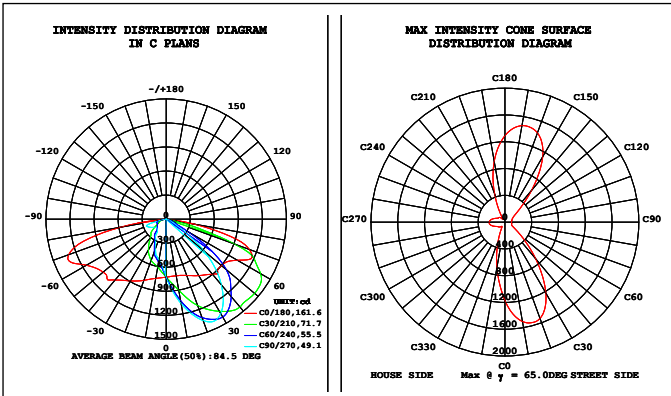

T2

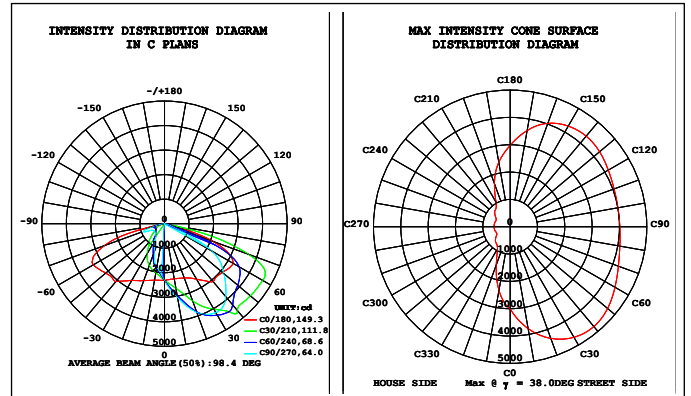

T3M

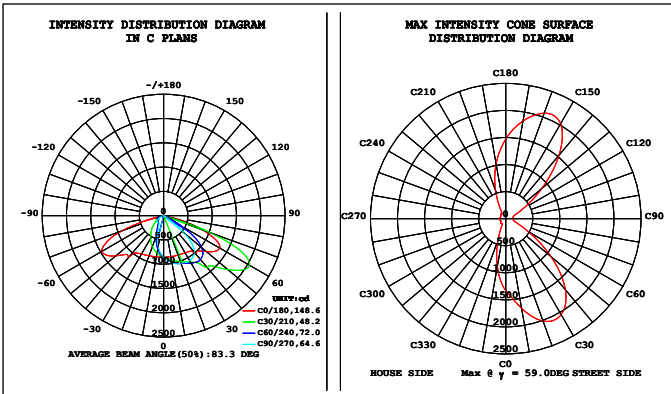

T3

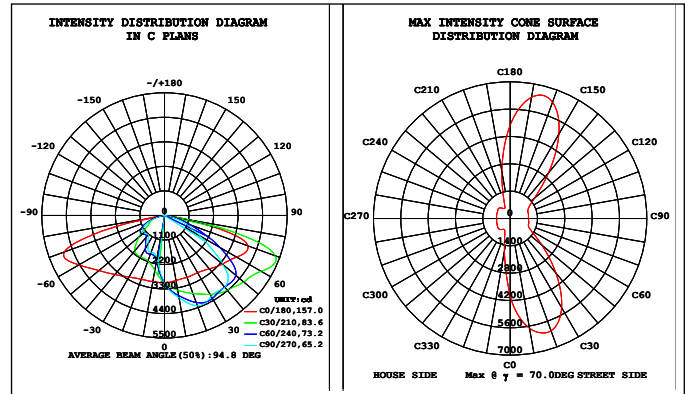

T3N

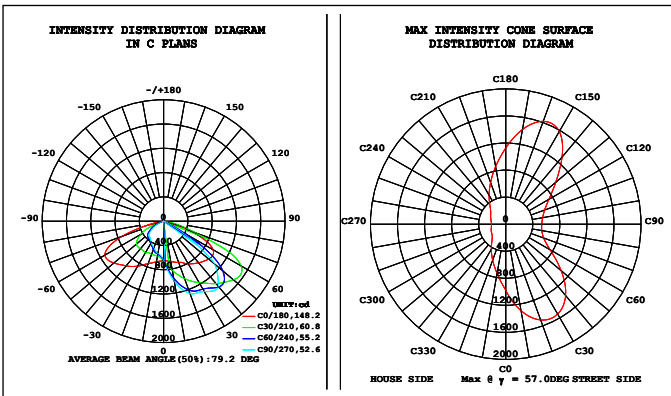

T4

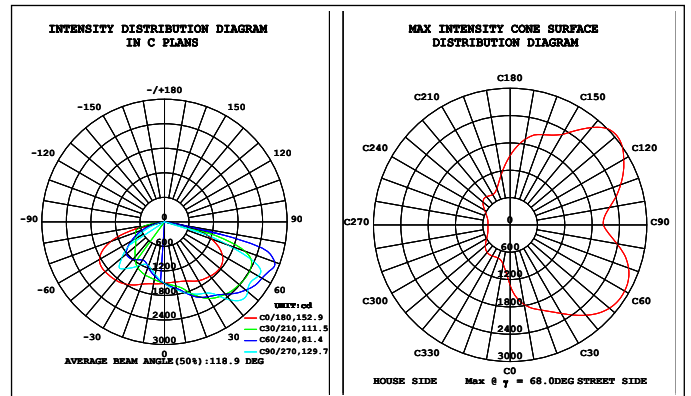

T4D

Dimensions

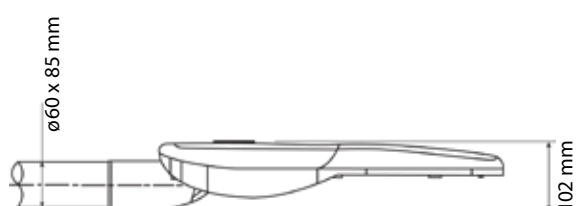
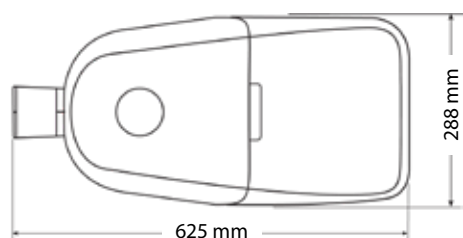

Features

- Smart City Ready - TST compatibility Zigbee, LoRa, NBloT
- High Performance luminaire designed to meet stringent Australian Standards AS/NZS 1158.6
- High Performance Optics designed to meet and comply Australian standards AS1158.1.1 Cat.V
- Integrated thermal management
- Segregated termination point
- Hinged 'quick access latch'
- Self-cleaning housing and optical diffuser
- 7-pin Nema Receptacle (7PN)
- Supports DALI-2 connection and complies with D4i
- 10 year warranty

Technical Data

- Body:** High Pressure Marine Grade Die Cast Aluminum
- Optics:** Type T2, T3, T3M, T3N, T4, T4D Distribution
- LED #:** 24 - 32 - 48
- Wattage:** 60 - 75 - 100 - 120 - 150 Watts
- Finishing:** Powder Coat (Grey Standard)
- Mounting:** 6 - 9 Metres
- Fixing:** Top or Side Mount (60mm OD)
- IP rating:** IP66
- IK rating:** IK08
- Voltage:** 240V 50/60Hz
- Power Factor:** >0.9

Options

- Fuse Terminal Block:** (FTB)
- Surge Protection Device:** SPD - 10KVA, 20KVA
- DALI-2, D4i**
- Street Light Controller:** Zhaga
- Class II:** (DB - Double Insulated)
- Colour:** Black (BL), Grey (GR-Standard)
- CCT:** 3000K, **4000K (Standard)**, 5000K
- Visor:** Glareshield/spill light kit (GV)
- Spigot Adapters Available:** 60mm to 34mm, 60mm to 42mm (OD), 60mm to 48mm (OD)

Specification FLAT-M

PRODUCT CODE	FL.M.60W	FL.M.75W	FL.M.100W	FL.M.120W	FL.M.150W
Photometric Distribution	T2, T3, T3M, T3N, T4, T4D	T2, T3, T3M, T3N, T4, T4D	T2, T3, T3M, T3N, T4, T4D	T2, T3, T3M, T3N, T4, T4D	T2, T3, T3M, T3N, T4, T4D
System Watts	60	75	100	120	150
Input Voltage (V)	240	240	240	240	240
CCT (K)	4000	4000	4000	4000	4000
CRI	Ra>70	Ra>70	Ra>70	Ra>70	Ra>70
IP Protection	IP66	IP66	IP66	IP66	IP66
IK Protection	IK08	IK08	IK08	IK08	IK08
Weight (Kg) - max.	7.5	7.6	7.6	7.6	7.6

Photometrics

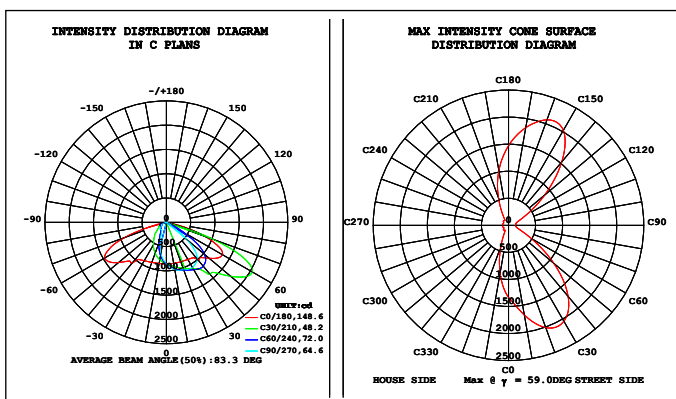

T3

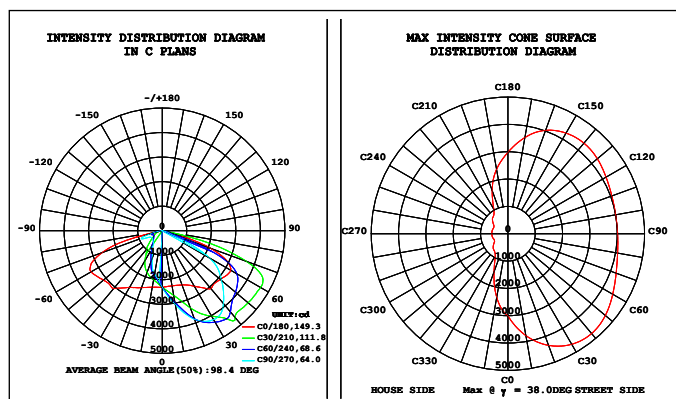

T3M

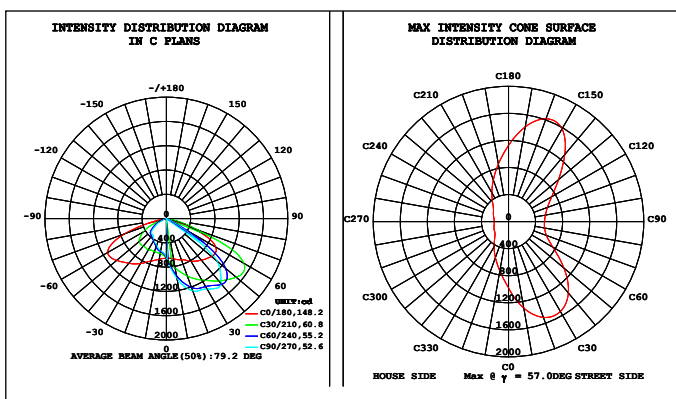

T4

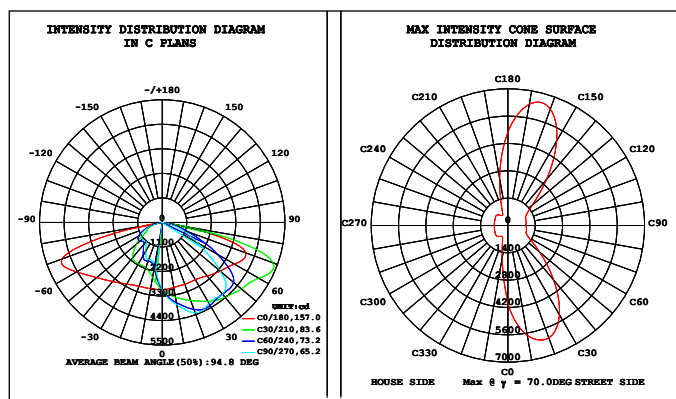

T3N

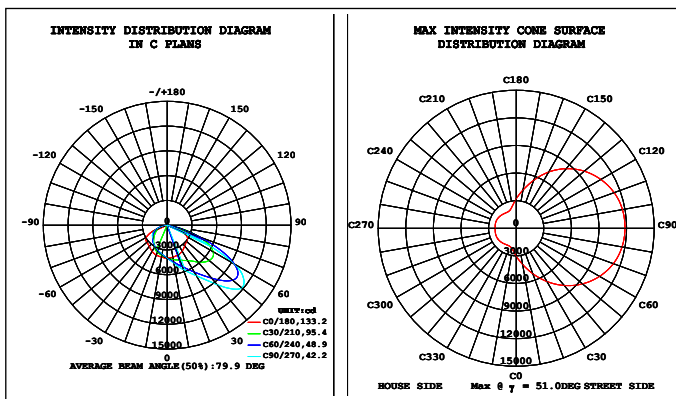

T5

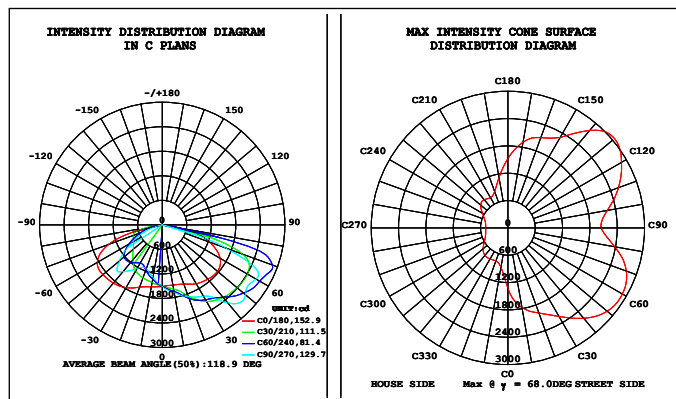

T4D

Dimensions

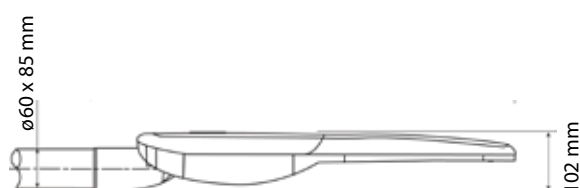
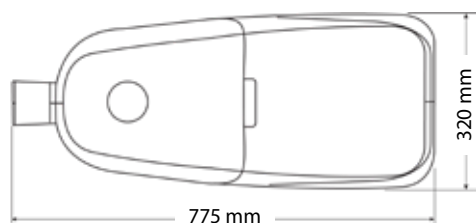

Technical Data

- **Body:** High Pressure Marine Grade Die Cast Aluminum
- **Optics:** Type T3, T3M, T3N, T4, T4D, T5 Distribution
- **LED #:** 48 - 64 - 96
- **Wattage:** 150 - 180 - 200 Watts
- **Finishing:** Powder Coat (Grey Standard)
- **Mounting:** 7 - 12 Metres
- **Fixing:** Top or Side Mount (60mm OD)
- **IP rating:** IP66
- **IK rating:** IK08
- **Voltage:** 240V 50/60Hz
- **Power Factor:** >0.9

Features

- Smart City Ready - TST compatibility Zigbee, LoRa, NBIoT
- High Performance luminaire designed to meet stringent Australian Standards AS/NZS 1158.6
- High Performance Optics designed to meet and comply Australian standards AS1158.1.1 Cat.V
- Integrated thermal management
- Segregated termination point
- Hinged 'quick access latch'
- Self-cleaning housing and optical diffuser
- 7-pin Nema Receptacle (7PN)
- Supports DALI-2 connection and complies with D4i
- 10 year warranty

Options

- **Fuse Terminal Block:** (FTB)
- **Surge Protection Device:** SPD - 10KVA, 20KVA
- **DALI-2, D4i**
- **Class II:** (DB - Double Insulated)
- **Colour:** Black (BL), Grey (GR-Standard)
- **CCT:** 3000K, **4000K (Standard)**, 5000K
- **Visor:** Glareshield/spill light kit (GV)
- **Spigot Adapters Available:** 60mm to 34mm, 60mm to 42mm (OD), 60mm to 48mm (OD)

Specification FLAT-L

PRODUCT CODE	FL.L.150W	FL.L.180W	FL.L.200W
Photometric Distribution	T3, T3M, T3N, T4, T4D, T5	T3, T3M, T3N, T4, T4D, T5	T3, T3M, T3N, T4, T4D, T5
System Watts	150	180	200
Input Voltage (V)	240	240	240
CCT (K)	4000	4000	4000
CRI	Ra>70	Ra>70	Ra>70
IP Protection	IP66	IP66	IP66
IK Protection	IK08	IK08	IK08
Weight (Kg) - max.	10.6	10.6	10.6

Photometrics

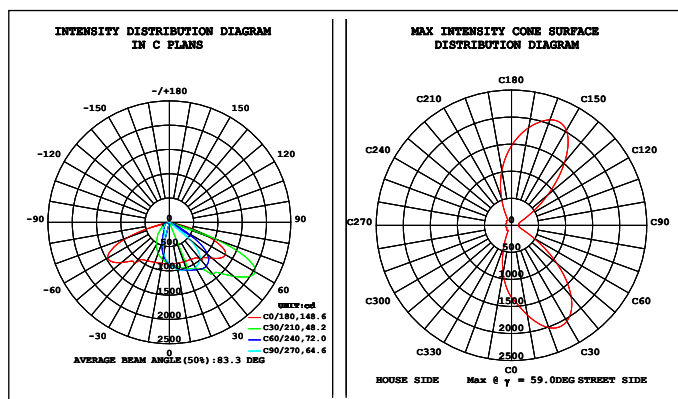

T3

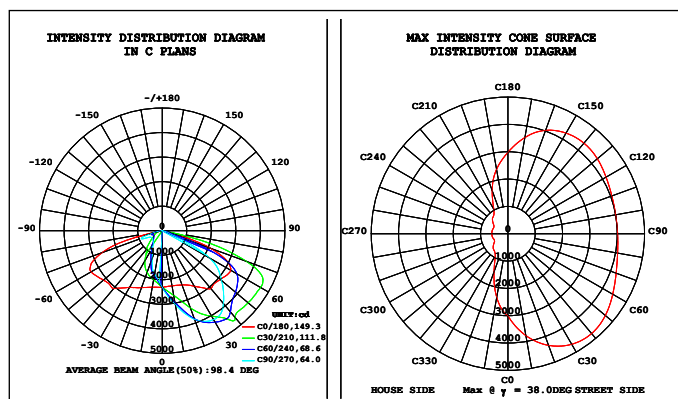

T3M

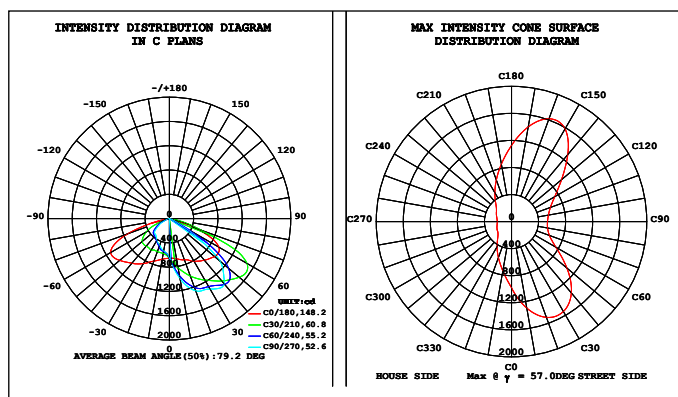

T4

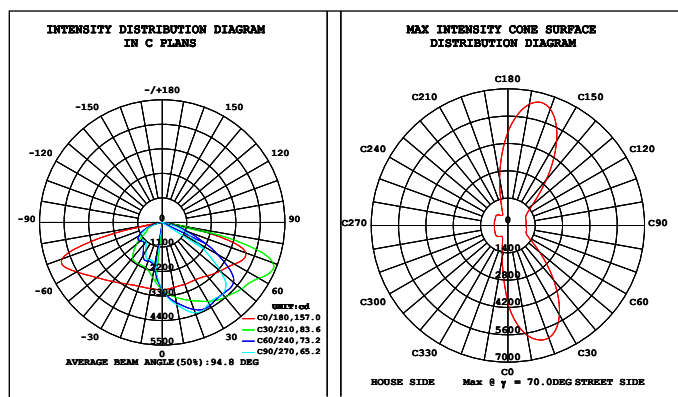

T3N

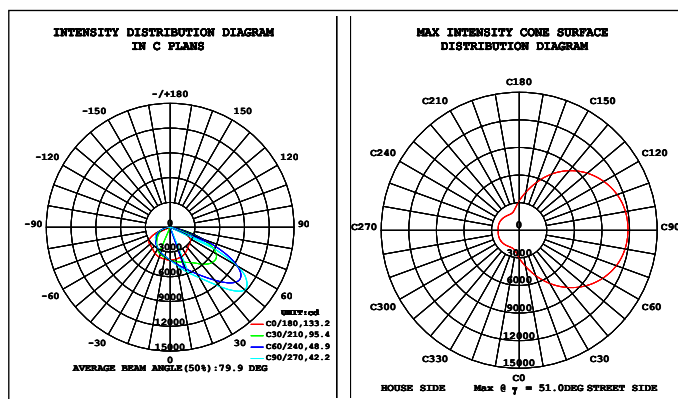

T5

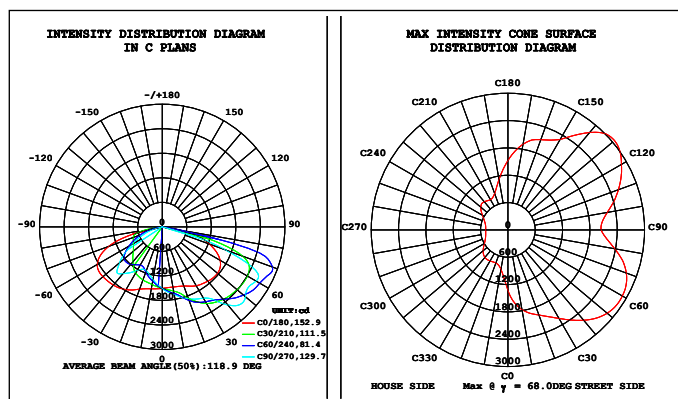

T4D

Residential Roads

TASMAN



PLED II



BERLIN



BOSTON SE



BOSTON TE



Highways and Major Roads

V-LED MKII



V-LED MKIII



BOSTON V



H-LED



E-LED



Residential Roads

COMO C



COMO P



COMO S



COMO T



FLAT S



FLAT M



FLAT L



Tunnels and Underpasses

T-LED



V-LED MKII



V-LED MKIII



FLUD S



FLUD M



FLUD L



FLUD X



S-LED





Aldridge Traffic Systems Pty Ltd

Unit 38, 38-46 South Street
Rydalmere NSW 2116

www.trafficltd.com.au



Before and After Installation - Hobart Tasmania

NSW

P: +61 2 9701 9900
e: info@trafficltd.com.au

VIC

P: +61 3 9430 0222
e: info@trafficltd.com.au

SA

P: +61 3 9430 0266
e: info@trafficltd.com.au

NT

P: +61 8 8947 0733
e: info@trafficltd.com.au

ACT

P: +61 2 6299 7922
e: info@trafficltd.com.au

WA

P: +61 8 9248 1002
e: info@trafficltd.com.au

QLD

P: +61 7 3184 2000
e: info@trafficltd.com.au

TAS

P: +61 3 6273 1177
e: info@trafficltd.com.au

UNITED KINGDOM

P: +44 (0) 1159 223 797
e: info@aldridgetraffic.co.uk

