

# ALDRIDGE

## E-LED



### Area Lighting System

# The Future of Area Lighting is Here

**Aldridge E-LED** is a brand new elite performance, multi application LED luminaire designed to illuminate sports fields, airports and large outdoor areas with supreme uniformity, outstanding light quality and remarkable visual comfort.

**Aldridge** Utilizing our patented fold fin thermal technology and latest high flux LEDs, **E-LED** emits more than 280,000 lumens from a single compact lightweight luminaire. The custom engineered optics are a breakthrough in LED beam control, enabling **E-LED** to deliver incredible photometric outputs that meet and exceed the most challenging of schemes.

## Benefits

- Very low windage area
- Multiple lumen packages to replace 400-2000 watt traditional lamps
- Easy direct replacement using the existing mast wiring and mounting arms
- Dark sky friendly with zero upward light
- Field adjustable
- Industry leading optical performance for light spill control
- Consistent high performance in the most demanding environments
- Compatible with leading programmable lighting control systems (optional)

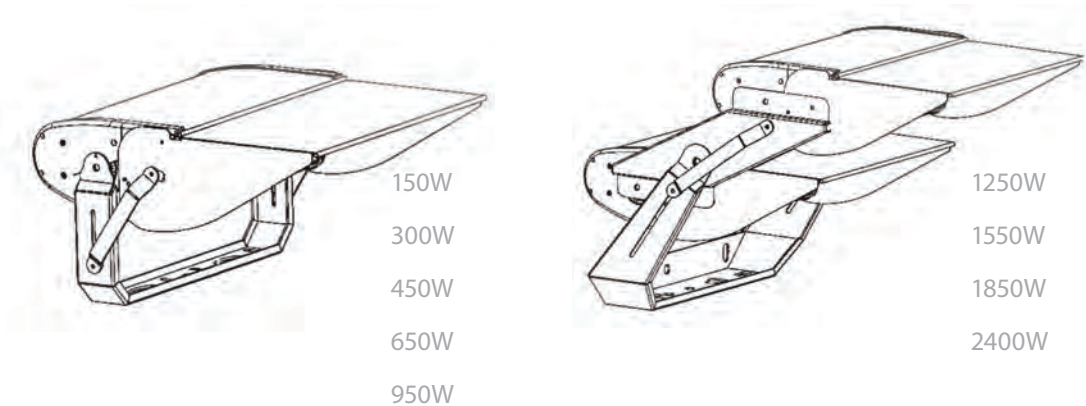

## Applications



STADIUMS

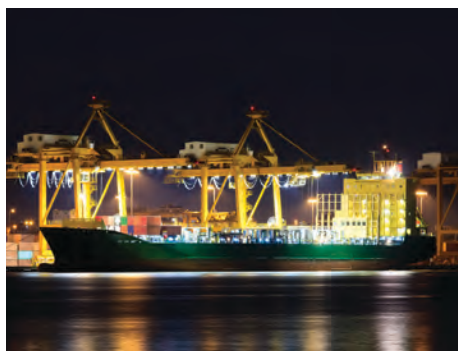

SHIP YARDS AND DOCKS



AIRPORTS

# KEY FEATURES

## A FOLD FINS

Patented lightweight thermal structure maximizes heat dissipation whilst maintaining a compact, lightweight, luminaire design.

## B MOUNTING SYSTEM

Versatile mounting bracket, designed for simple install in new or retro fit applications.

## C ADJUSTING

Simple to adjust for final aiming.

## D FINISH

Polyester powder paint provides a highly durable finish that is resistant to UV rays and corrosion.

## E HOOD

Eliminates upward light leakage and provide excellent control of spill light.

## F OPTICS

Eight custom-engineered optics that direct light precisely where needed whilst minimizing glare.

## G IP66 ENCLOSURE

Weather-tight design ensures durability and reliability in the harshest environments.

## H LEDS

Long life, high density L80 >100,000 hours  
Ta 45°C.

## I GLASS

Heat, shock and vandal resistant, toughened glass lens, with high light transmission.

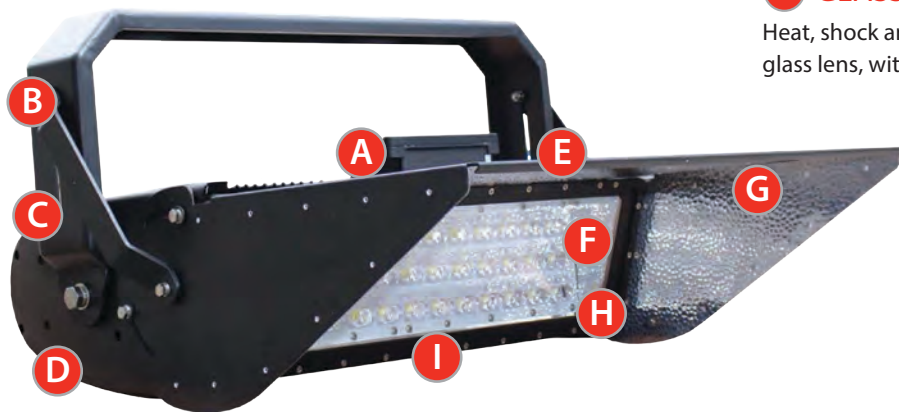

## Install

**E-LED** is designed to be installed on existing lighting poles and infrastructures and can be mounted above or below a crossbar simply by inverting the brackets. This allows multiple lights to be fitted on each mast, eliminating the expenses for new poles, crossarms, demolition, engineering and foundations.

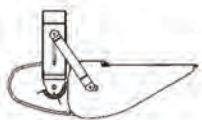

TOP



SIDE

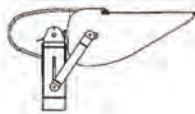

BOTTOM

## Driver System

### PERFORMANCE

The power gear enclosure is designed to minimize driver operating temperatures so it runs cooler significantly improving reliability and performance.

### CONTROL

The power control technology delivers constant light output, independent of input voltage variations and runs efficiently of >96% and a factor of 0.99°.

### FLEXIBILITY

The complete power gear system can be located up to 50m away from the luminaires, making it ideal for remote mounting. This simplifies installation, lowers initial cost and enables easy access for maintenance and future upgrades.



## PRODUCT PARAMETER

Model No.	System Power	Input Voltage	Luminous Flux	Dimensions	Weight
ELED-150	150W	120-277V / 347-480V 50/60Hz	17,100lm	630x610x222mm	13.5kg
ELED-300	300W	120-277V / 347-480V 50/60Hz	34,200lm	630x610x222mm	13.5kg
ELED-450	450W	120-277V / 347-480V 50/60Hz	47,000 lm	630x610x222mm	13 kg
ELED-650	650W	120-277V / 347-480V 50/60Hz	70,500 lm	630x610x222mm	15 kg
ELED-950	950W	120-277V / 347-480V 50/60Hz	102,000 lm	630x610x222mm	24 kg
ELED-1250	1250W	120-277V / 347-480V 50/60Hz	135,000 lm	964x675x452mm	35 kg
ELED-1550	1550W	120-277V / 347-480V 50/60Hz	170,000 lm	964x912x452mm	43 kg
ELED-1850	1850W	120-277V / 347-480V 50/60Hz	205,000 lm	964x912x452mm	55 kg
ELED-2450	2450W	120-277V / 347-480V 50/60Hz	281,500lm	964x912x452mm	66.5kg

## SPECIFICATIONS

Light Source	Lumileds / CREE
CCT	4000K / 5000K / 6500K
CRI	>70 CRI (>80 & >90 CRI also available)
Dimming	0-10V, DALI
Material	Aluminum (body) Galvanized Steel (bracket)
Finish	Polyester Coating
Ingress Protection	IP65
Lifespan	100,000 H
Operating Temp	-40°C to +45°C
Certifications	

## PHOTOMETRICS

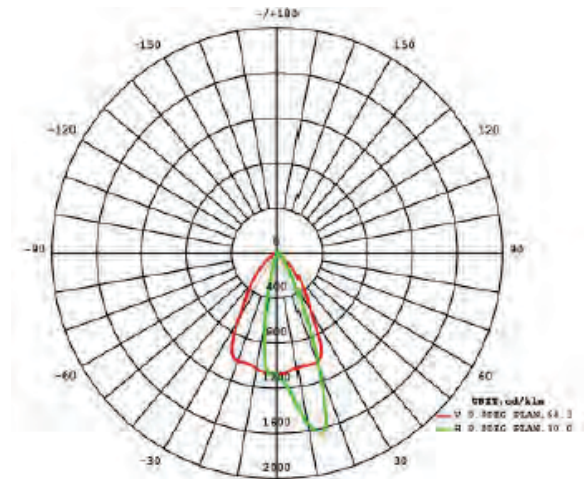

## ORDER CODES

Product ID	LED Power	Color Temp	CRI	Optics	Color
ELED	015 = 150W	40K = 4000K	70 = Min 70	FT = Far Throw ML = Medium Left MR = Medium Right SR = Short Left SR = Short Right R1 = Round 15" x 15" R3 = Round 30" x 30" R6 = Round 60" x 60"	GR = Grey BL = Black
	030 = 300W				
	045 = 450W				
	065 = 650W	50K = 5000K	80 = Min 80		
	095 = 950W	65K = 6500K	90 = Min 90		
	125 = 1250W				
	155 = 1550W				
	185 = 1850W				
	240 = 2450W				

## ACCESSORIES

Laser Aimer. Customized Brackets Upon Request.

\*\* FOR DETAIL PRODUCT SPECIFICATIONS, PLEASE CONTACT OUR SALES REPRESENTATIVES. ORDER CODES

